

NEW

ELECTRIC HEATING VORTICE



VENTILATION
AIR CONDITIONING
AIR CLEANING
HEATING



Air is life

We work to promote quality of life and to contribute to social evolution through eco-friendly products that move air safely and efficiently.



Electric Heating Vortice

4 | CALDOMI



Portable floor standing or wall mounted fan heater for auxiliary heating

6 | SCALDATUTTO CLASSIC



Portable fan heaters for background heating

8 | CALDORÉ



Portable or wall mounted convectors and fan heaters for auxiliary heating

10 | MICROCOMFORT



Wall mounted fan heater for auxiliary heating, also for use as a towel heater

12 | MICRORAPID VO



Fan heaters for wall installation with or without timer

14 | MICROSOL VO



Wall-mounting convector heaters

16 | THERMOLOGIKA SOLEIL PLUS



Infrared heater for indoor/outdoor local heating

18 | PALOLOGIKO



Stand for Thermologika Soleil Plus

NEW

20 | THERMOLOGIKA



Infrared wall heater for auxiliary heating

22 | CALDOPRO PLUS



Professional fan heaters portable and for wall installation

24 | TIRACAMINO



Radial extract unit for chimney tops

25 | CENERELLO



The ashes-eater

25 | CALDOFÀ



Fireplace fan heater

ELECTRIC HEATING

CALDOMI

PORTABLE FLOOR STANDING OR WALL MOUNTED FAN HEATER FOR AUXILIARY HEATING

Product specifications:

- Two power settings: 1000 and 2000 W.
- Needle type heating element.
- Manual reset thermal cut-out
- Room thermostat for setting and maintaining the desired room temperature.
- Anti-frost function to switch the fan heater on automatically if ambient temperature drops below 5°C.
- Rotary switch to select desired operating mode:
 - low power (1000 W)
 - high power (2000 W)
- 2 metre power cable complete with Schuko type plug.



KEY FEATURES

- Wall mounting bracket and spacers included.
- Especially silent running makes it ideal for use during the night.
- Integrated retractable foot.
- Wall installation with supplied bracket.



DIMENSIONS

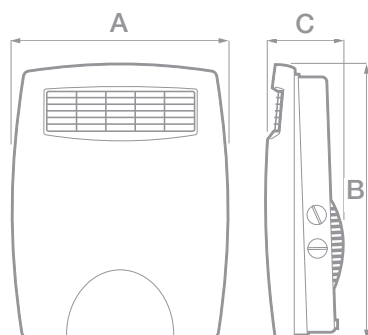

Model	Code	A	B	C	Kg
CALDOMI	70299	290	375	100	1.85

Dimensions (mm)

TECHNICAL DATA

MODEL	Code	V	Hz	Power setting W	A	Insulation	IP
CALDOMI	70299	230	50	1000/2000	8.7	 cl.II	X1

APPLICATIONS



SCALDATUTTO CLASSIC



PORTABLE FAN HEATER FOR AUXILIARY HEATING

Product specifications:

- 2 power settings: 1000 W and 2000 W
- Can be wall-mounted by using the accessory supplied.
- Made of V0 self-extinguishing thermoplastic material, this material has the highest self-extinguishing capability.
- Ambient temperature thermostat.
- Cable storage compartment.
- Complies with CEI EN 60335-2-30 standards.
- Anti-frost function.
- 1,5 metre power cable complete with Schuko type plug.



KEY FEATURES

- Very compact, attractive design, this unit is suitable for all types of rooms and decor.
- Very safe because a thermal cut out turns the power off if the resistance overheats.
- Can also be used in the summer as a cooling fan.
- Ideal when the existing heating system is either insufficient or not functioning.

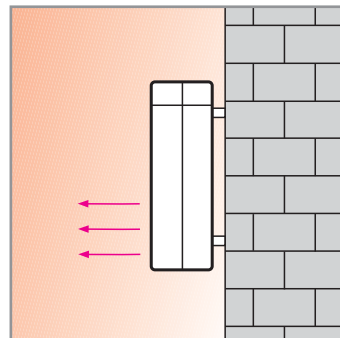

DIMENSIONS

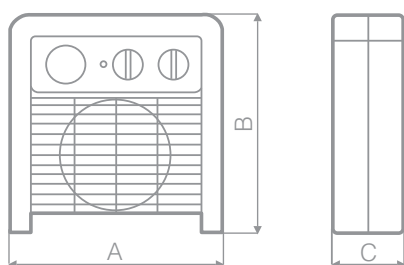

Model	Code	A	B	C	Kg
SCALDATUTTO CLASSIC FH-VO	70141	290	331	120	1.9

Dimensions (mm)

TECHNICAL DATA

MODEL	Code	V	Hz	Power Setting W	A	Insulation	IP
SCALDATUTTO CLASSIC FH-VO	70141	230	50	1000/2000	9	 cl.II	X1

APPLICATIONS





PORTABLE OR WALL MOUNTED CONVECTORS AND FAN HEATERS FOR BACKGROUND HEATING

Product specifications:

- Three models: convector heater (Caldorè), fan-assisted heater (Caldorè R) and fan-assisted heater with timer (Caldorè RT).
- Three POWER SETTINGS: 800/1200/2000 W.
- The RT model has a programmable 24 h timer which can be set to nearest 15 min.
- Self-extinguishing material
- Anti-frost function.
- Illuminated control switches for fast, easy operation.
- 1,6 metre power cable complete with Europlug.



KEY FEATURES

- Convenient handles for carrying and moving.
- Rubber feet for improved stability
- Optional wall-mounting fixings (code 22980).



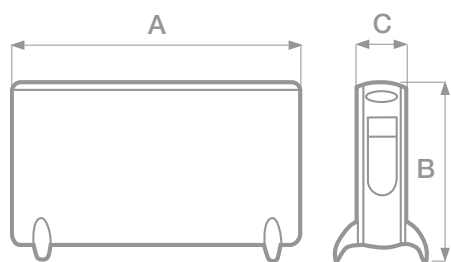

DIMENSIONS



Model	Code	A	B	C	Kg
CALDORÉ	70201	580	415	100	3.9
CALDORÉ R	70211	685	415	100	5.2
CALDORÉ RT	70221	685	415	100	5.3

Dimensions (mm)

TECHNICAL DATA

MODEL	Code	V	Hz	Power Setting W	A	Insulation
CALDORÉ	70201	230	50	800/1200/2000	8.7	 cl.II
CALDORÉ R	70211	230	50	800/1200/2000	8.7	 cl.II
CALDORÉ RT	70221	230	50	800/1200/2000	8.7	 cl.II

ACCESSORIES

MODEL	CODE
WALL-MOUNTING KIT	22980

APPLICATIONS



MICROCOMFORT

WALL MOUNTED FAN HEATER FOR AUXILIARY HEATING, ALSO FOR USE AS A TOWEL HEATER



Product specifications:

- Two power settings: 1000 and 2000 W.
- Needle type heating element.
- Manual reset thermal cut-out.
- For wall mounting only
- Room thermostat for setting and maintaining the desired room temperature.
- Anti-frost function to switch the fan heater on automatically if ambient temperature drops below 5°C.
- Rotary switch on left side to select desired operating mode:
 - low power (1000 W)
 - high power (2000 W)
- 2 metre power cable complete with Schuko type plug.



KEY FEATURES

- Both silent running and extremely effective.
- Efficient towel heater: warm air brings your bath towels to a delightfully welcoming temperature, a luxury that, once tried you will never want to do without.
- Especially elegant, is a stylish addition to any room, wherever you choose to install it.
- Comes complete with stainless steel towel holder.



DIMENSIONS

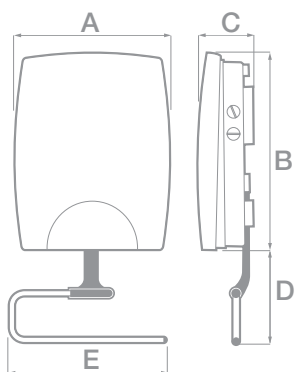

Model	Code	A	B	C	D	E	Kg
MICROCOMFORT	70870	385	460	130	200	370	2.45

Dimensions (mm)

TECHNICAL DATA

MODEL	Code	V	Hz	Power Setting W	A	Insulation	IP
MICROCOMFORT	70870	230	50	1000/2000	8.7	 cl.II	X3

APPLICATIONS



MICRORAPID



WALL-MOUNTED FAN HEATERS WITH AND WITHOUT TIMER

Product specifications:

- 8 models with different powers (600/1000/1500/2000 W) with and without weekly digital timer.
- Protected against splashes of water (protection class X4), they can be installed in damp environments.
- The timer versions have a daily/weekly digital programmer.
- Room thermostat to set the temperature.
- Also equipped with a “no frost” function that switches the unit on automatically when the temperature drops under 5 °C.
- The resin parts have high mechanical strength even at high temperatures (V0 self extinguishing plastic).



KEY FEATURES

- Small dimensions for installations in cramped areas.
- Operational safety, sturdiness, ergonomics and stylish aesthetics.
- Extremely silent (tangential fan drive), suitable for bedroom installation.
- Easy to install: the electric connections can be made with the unit installed on the wall.
- Digital display protected by a lift-up door.
- Stand-by luminous control.

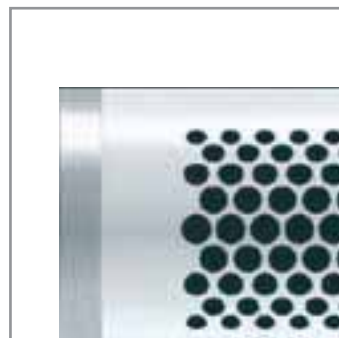



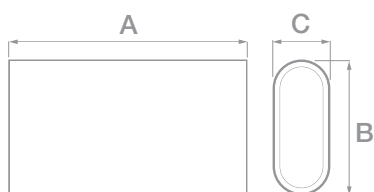





DIMENSIONS



Models	Code	A	B	C	Kg
MICRORAPID 600 - V0	70602	433	258	109	3.0
MICRORAPID 1000 - V0	70612	503	258	109	3.7
MICRORAPID 1500 - V0	70622	573	258	109	3.8
MICRORAPID 2000 - V0	70632	633	258	109	4.2
MICRORAPID T 600 - V0	70653	433	258	109	3.0
MICRORAPID T 1000 - V0	70661	503	258	109	3.7
MICRORAPID T 1500 - V0	70663	573	258	109	3.8
MICRORAPID T 2000 - V0	70681	633	258	109	4.2

Dimensions (mm)

TECHNICAL DATA

MODEL	Code	V	Hz	Power Setting W	A	Insulation	IP
MICRORAPID 600 - V0	70602	230	50	300/600	2.6	 cl.I	X4
MICRORAPID 1000 - V0	70612	230	50	500/1000	4.3	 cl.I	X4
MICRORAPID 1500 - V0	70622	230	50	500/1000/1500	6.5	 cl.I	X4
MICRORAPID 2000 - V0	70632	230	50	800/1200/2000	8.7	 cl.I	X4
MICRORAPID T 600 - V0	70653	230	50	300/600	2.6	 cl.I	X4
MICRORAPID T 1000 - V0	70661	230	50	500/1000	4.3	 cl.I	X4
MICRORAPID T 1500 - V0	70663	230	50	500/1000/1500	6.5	 cl.I	X4
MICRORAPID T 2000 - V0	70681	230	50	800/1200/2000	8.7	 cl.I	X4

APPLICATIONS



MICROSOL



WALL-MOUNTING CONVECTOR HEATERS

Product specifications:

- 4 models with different powers (600/1000/1500/2000 W).
- Protected against splashes of water (protection class X4), they can be installed in damp environments.
- Room thermostat to maintain the set temperature.
- Also equipped with a “no frost” function that switches the unit on automatically when the temperature drops under 5 °C.
- The resin parts have high mechanical strength even at high temperatures (V0 self extinguishing plastic).



KEY FEATURES

- Totally silent operation (no motor inside) makes it particularly useful when there is no central heating.
- Compact dimensions for installations in cramped areas.
- Easy to install: the electric connections can be made with the unit installed on the wall.
- Luminous controls protected by a lift-up door.
- Stand-by luminous control.



DIMENSIONS

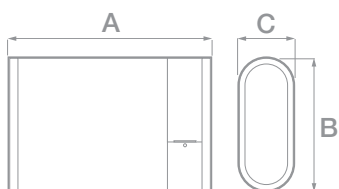

Model	Code	A	B	C	Kg
MICROSOL 600 - V0	70562	463	258	109	2.9
MICROSOL 1000 - V0	70572	573	258	109	3.2
MICROSOL 1500 - V0	70582	723	258	109	3.9
MICROSOL 2000 - V0	70592	863	258	109	4.6

Dimensions (mm)

TECHNICAL DATA

MODEL	Code	V	Hz	Power Setting W	A	Insulation	IP
MICROSOL 600 - V0	70562	230	50	300/600	2.6	⏏ cl.I	X4
MICROSOL 1000 - V0	70572	230	50	500/1000	4.3	⏏ cl.I	X4
MICROSOL 1500 - V0	70582	230	50	500/1000/1500	6.5	⏏ cl.I	X4
MICROSOL 2000 - V0	70592	230	50	800/1200/2000	8.7	⏏ cl.I	X4

APPLICATIONS



THERMOLOGIKA SOLEIL PLUS



IPX5

Products are protected against jets of water and therefore suitable for installation outdoors

INFRARED HEATER

FOR INDOOR/OUTDOOR LOCAL HEATING

Product specifications:

- 1 model for wall or ceiling installation, horizontally or vertically, particularly suited in all cases where strong heating is required in localised areas.
- Aluminium made front grille
- Side covers in die-casted aluminium
- Casing in extruded aluminium epoxy polyester painted.
- Metal bracket for wall mounting (supplied as standard).
- **Lamp (bulb)**
Based on Halogen HeLen technology, the bulb fitted in the Thermologika Soleil Plus is guaranteed to be highly efficient, long lasting (5000 h in an open environment) and suitable for operation down to -20° C.



KEY FEATURES

- Strong and lightweight.
- High protection grade (IPX5) which makes the product particularly suited to outdoor use.
- The principle of radiation (like the sun itself) assures the efficient transmission of heat to the areas to be heated with no air dispersion.
- Immediate heat delivery (more than 90% of the heat is generated in around 1 second, compared to the 30 seconds needed on average to complete the standard ON/OFF cycle of a conventional quartz bulb).
- Heat concentrated in specifically targeted areas.
- No combustion, no risk of odours or polluting agents.
- Irradiated heat distribution not affected by air currents.
- High radiating efficiency, offering significant energy savings.
- Safe use (the quartz bulb guarantees high resistance to thermal shock).
- Reduced maintenance and high reliability

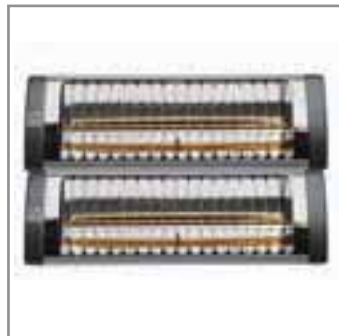

DIMENSIONS

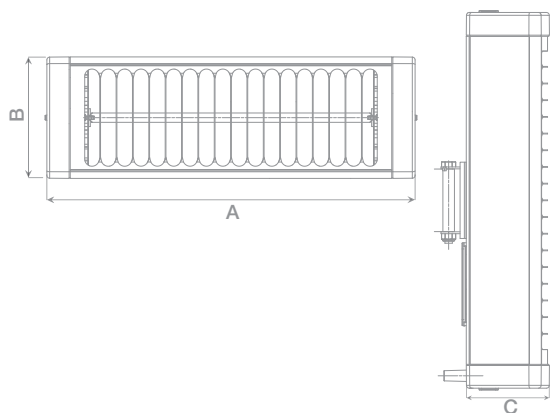

Model	Code	A	B	C	Kg
THERMOLOGIKA SOLEIL PLUS	70065	395	130	120	1.5

Dimensions (mm)

TECHNICAL DATA

MODEL	Code	V	Hz	W	A	Insulation	IP
THERMOLOGIKA SOLEIL PLUS	70065	230	50	1500	6.5	 cl.I	X5



ACCESSORIES

MODEL	Code
HORIZONTAL/VERTICAL INSTALLATION KIT	22970
POWER REGULATOR	22974

POWER REGULATOR
To switch on/off and adjust the heat delivery, with power variation from 30 to 100 %.
Operating Voltage: 230V~50Hz
Max Power : 3000 W
Operating Temperature : 0°C – 40°C
Protection : IP20
Insulation : Class II.

APPLICATIONS



PALOLOGIKO

NEW



IPX5

Products are protected against jets of water and therefore suitable for installation outdoors



KEY FEATURES

- Suitable for areas where other types of fixture are not possible.
- The lamps can be mounted vertically or horizontally and can be adjusted to direct the heat where needed.
- Stylish design.
- Possibility to fix the base to the floor.
- The lamps are positioned at a height that complies with european standards (EN 60335-2-30).



STAND FOR THERMOLOGIKA SOLEIL PLUS

SUPPORTS UP TO 3 LAMPS*

Product specifications:

- Useful accessory on which 1 to 3 lamps can be fitted.
- Maximum power: 4500 W (with 3 lamps installed)
- Height: 2.27 m.
- The connection cable can be routed inside the stand, from the bottom, or can be positioned at the top.
- Epoxy polyester painted steel.
- Flat base with rubber feet
- Protection: IPX5.
- Colour: aluminium.

* Delivered without lamps.

DIMENSIONS

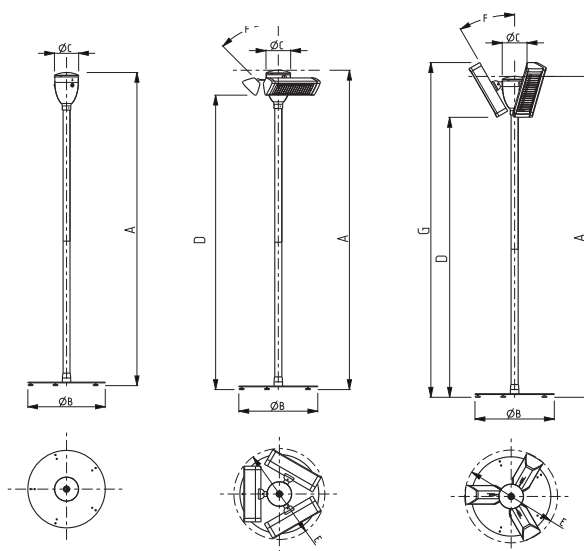

Model	Code	A	Ø B	Ø C	D	E	F	G	Kg
PALOLOGIKO (vertical)	22499	2270	560	175	1970	655	30°	2365	17
PALOLOGIKO (horizontal)	22499	2270	560	175	2090	645	45°	//	17

Dimensions (mm)

TECHNICAL DATA

MODEL	Code	V	Hz	W	Insulation	IP
PALOLOGIKO	22499	230	50	1500-4500	cl.I	X5

APPLICATIONS



THERMOLOGIKA

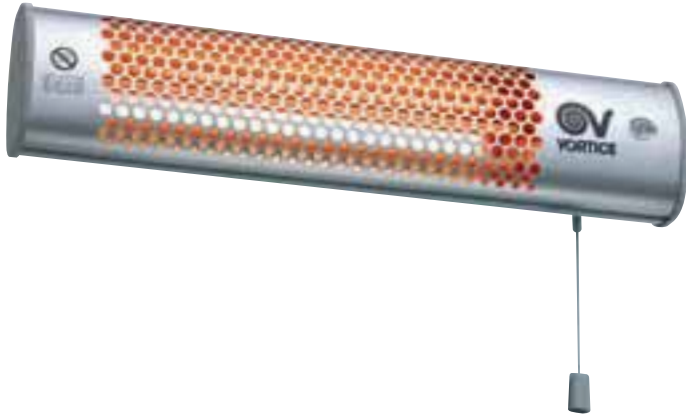

INFRARED WALL HEATER FOR AUXILIARY HEATING

Product specifications:

- IPX4 splashproof protection, can be installed in rooms with high relative humidity.
- Heat Up Time: approximately 30 sec.
- Choice of 3 power outputs: 600/1200/1800 W with a pull switch, the power output appears automatically.
- Can be adjusted (22° range) to direct the heat where needed.
- Can be switched on and off remotely.
- Acts instantly, even in cold rooms.
- Quartz bulb.



KEY FEATURES

- Suitable for domestic and commercial applications. ideal when instant heat is necessary or in places in direct and continuous contact with the outside.
- It heats by radiation, the heat spreads directly at the speed of light straight to the solid bodies with the same principle as solar radiation.
- Wall installation with compact dimensions.
- Maximum silence: it has no moving parts.
- Easy installation

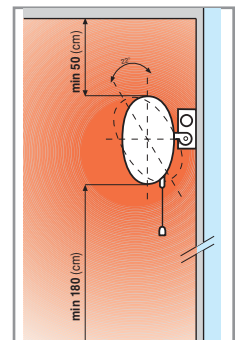

DIMENSIONS

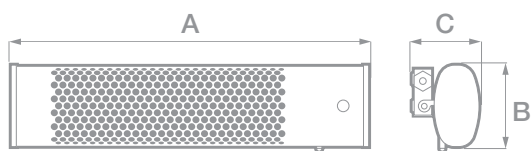

Model	Code	A	B	C	Kg
THERMOLOGIKA	70002	540	123	100	1.6

Dimensions (mm)

TECHNICAL DATA

MODEL	Code	V	Hz	Power Setting W	A	Insulation	IP
THERMOLOGIKA	70002	230	50	600/1200/1800	7.8	 cl.I	X4

ACCESSORIES

MODEL	Code
QUARTZ BULB	22985

APPLICATIONS



CALDOPRO PLUS



PROFESSIONAL FAN HEATERS PORTABLE AND FOR WALL INSTALLATION

Range and products specifications:

- 3 models: different power (3 kW to 5 kW) and supply voltage (single and three phase).
- Cylindrical steel body with intake and outlet grilles.
- Fan motor unit with single speed shielded pole motor. Aluminium 5-blade fan.
- Control panel located on the main cylindrical casing, made of self-extinguishing V0, ABS painted with integrated carrying handle.
- Mechanical timer, max 180 minutes, for setting delayed switch-off.
- Support feet in painted steel sheet with anti-vibration supports.
- Supply cable with industrial 4-pole safety plug for three-phase models and schuko plug for single phase model, nominal cable length 1800 mm.



KEY FEATURES

- For auxiliary heating in laboratories, shops, warehouses and homes.
- Splashproof (protection IPX4) particularly suited also for use in the presence of water.
- Bulb-type thermostat guarantees greater accuracy.
- Equipped with bracket for wall installation



DIMENSIONS

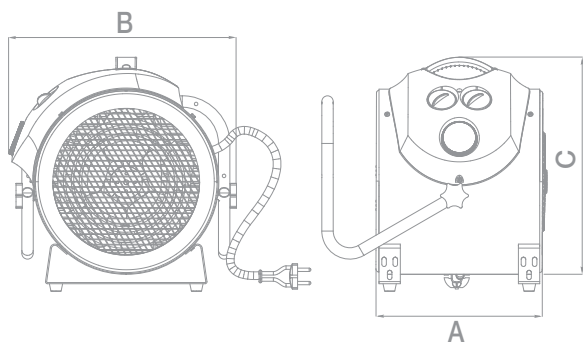

Models	Code	A	B	C	Kg
CALDOPRO PLUS 3000 M	70805	238	300.5	335	5.4
CALDOPRO PLUS 3000 T	70806	238	300.5	335	5.4
CALDOPRO PLUS 5000 T	70807	238	300.5	335	5.4

Dimensions (mm)

TECHNICAL DATA

Model	Code	V	Hz	W	A	Cl.	IP
CALDOPRO PLUS 3000 M	70805	230	50	3000	13	Ⓡ cl.I	X4
CALDOPRO PLUS 3000 T	70806	400	50	3000	4.3	Ⓡ cl.I	X4
CALDOPRO PLUS 5000 T	70807	400	50	5000	7.2	Ⓡ cl.I	X4

APPLICATIONS





RADIAL EXTRACT UNIT FOR CHIMNEY TOPS

Product specifications and key features:

- Designed to draw out smoke from fireplace (200 C° approximately). Can be used as a normal extractor fan when the fireplace is not lit.
- Not suitable for use with gas fires.
- Complete with variable speed controller C 1.5 and base frame.
- Optional protective grille (code 22700) for covering the moving parts when the unit is installed at low level.
- Optional SCB Kit (code 22481) to flush-mount the C1.5 control unit.
- Weather proof steel construction and anti-corrosion, polyester resin protection.
- Supplied with steel safety cable to safely secure the fan to the base.

DIMENSIONS

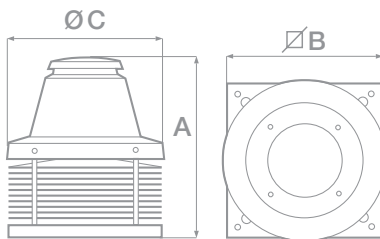

Model	Code	A	ØB	ØC	Kg
TIRACAMINO	15000	518	410	405	14.3

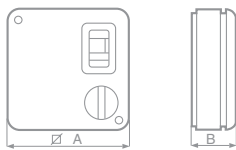

Model	Code	ØA	B	Kg
C 1.5	12966	120	43	0.2

Dimensions (mm)

TECHNICAL DATA

MODEL	Code	V	Hz	W	A	Rpm	Delivery (m ³ /h)	Pmax (Pa)	Lp dB(A)	Inlet Ø mm	Cl.	IP
TIRACAMINO	15000	220-240	50	120	0.5	1400	750	186	52	170	Cl.I	X4

CENERELLO

THE ASHES-EATER



Product specifications and key features:

- Designed to operate in conjunction with any standard vacuum cleaner which produces a vacuum of 1000 to 3000 mm of H₂O, except for battery-operated models, rechargeable models and models without a collection bag or filter.
- Picks up ash from all types of fireplaces, stoves and bar becuces. Will also collect dirt, shavings, sawdust, debris, etc. from the floor.
- Easy to use and to clean, the vacuumed material goes straight into Cenerello's body without ruining or blocking up the vacuum cleaner. The collected debris is easy to empty directly into a rubbish bin.

DIMENSIONS

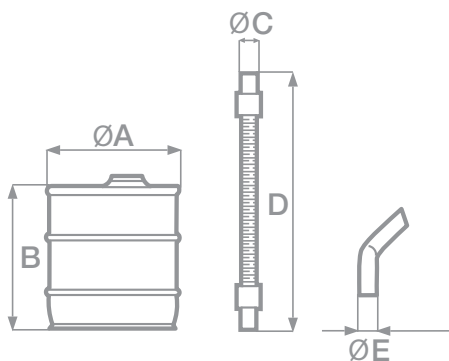

Model	Code	ØA	B	ØC	D	ØE	Kg
CENERELLO	22994	300	330	45	1200	38	3

Dimensions (mm)

CALDOFÀ

FIREPLACE FAN HEATER



Product specifications and key features:

- It's very simple and easy to operate. Simply place it in the centre of the fireplace and light the fire.
- Caldofà® draws in cold air from the room, which is then heated by burning firewood, and sends the row heated air back into the room to circulate.
- It provides significant savings in heating costs, reducing the time your main heating system needs to be on.
- Spark screen (supplied) prevents small sparks from falling out of the fireplace.

DIMENSIONS

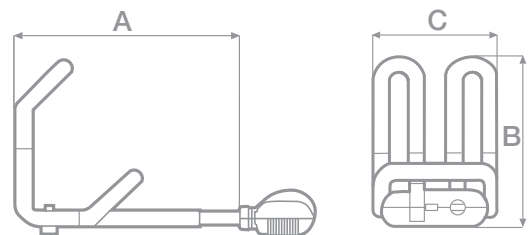

Model	Code	A	B	C	Kg
CALDOFÀ	70710	500-830	450	348	18

Dimensions (mm)

TECHNICAL DATA





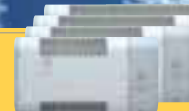
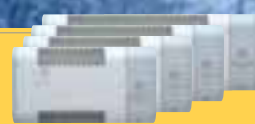







MODEL	Code	V	Hz	W	Insulation	IP
CALDOFÀ	70710	220-240	50	20	□ Cl.II	21

THE RANGE



PRODUCTS	CALDOMI	SCALDATUTTO CLASSIC	CALDORÉ	CALDORÉ R	CALDORÉ RT	MICROCOMFORT	MICRORAPID VO				MICRORAPID VO TIMER	
							600	1000	1500	2000	600	1000
Code	70299	70140	70201	70211	70221	70870	70602	70612	70622	70632	70653	70661
V	230	230	230	230	230	230	230	230	230	230	230	230
Hz	50	50	50	50	50	50	50	50	50	50	50	50
W	2000	2000	2000	2000	2000	2000	600	1000	1500	2000	600	1000
A	8.7	9	8.7	8.7	8.7	8.7	2.6	4.3	6.5	8.7	2.6	4.3
Power settings	2	2	3	3	3	2	2	2	3	3	2	2
Daily/weekly timer	NO	NO	NO	NO	YES	NO	NO	NO	NO	NO	YES	YES
Mechanical timer	NO	NO	NO	NO	NO	NO	NO	NO	NO	NO	NO	NO
Approvals												
Marked	CE	CE	CE	CE	CE	CE	CE	CE	CE	CE	CE	CE
Insulation	Cl. II	Cl. II	Cl. II	Cl. II	Cl. II	Cl. II	Cl. I	Cl. I	Cl. I	Cl. I	Cl. I	Cl. I
IP	IPX1	IPX1	-	-	-	IPX3	IPX4	IPX4	IPX4	IPX4	IPX4	IPX4
Weight kg	1.85	1.9	3.9	5.2	5.3	2.45	3	3.7	3.8	4.2	3	3.7

* Delivered without lamps.

		MICROSOL VO				THERMOLOGIKA SOLEIL PLUS	NEW PALOLOGIKO*	THERMOLOGIKA	CALDOPRO PLUS 3000 M	CALDOPRO PLUS 3000 T	CALDOPRO PLUS 5000 T	TIRACAMINO	CENERELLO	CALDOFÀ
1500	2000	600	1000	1500	2000									
70663	70681	70562	70572	70582	70592	70065	22499	70002	70805	70806	70807	15000	22994	70710
230	230	230	230	230	230	230	230	230	230	400 trifase	400 trifase	220-240	-	220-240
50	50	50	50	50	50	50	50	50	50	50	50	50	-	50
1500	2000	600	1000	1500	2000	1500	1500 3000 4500	1800	3000	3000	5000	120	-	20
6.5	8.7	2.6	4.3	6.5	8.7	6.5	-	7.8	13	4.3	7.2	0.5	-	-
3	3	2	2	3	3	1	3	3	1	1	1	1	-	1
YES	YES	NO	NO	NO	NO	NO	NO	NO	NO	NO	NO	NO	-	NO
NO	NO	NO	NO	NO	NO	NO	NO	NO	YES	YES	YES	NO	-	NO
							-						-	 CSV
CE	CE	CE	CE	CE	CE	CE	CE	CE	CE	CE	CE	CE	-	CE
Cl. I	Cl. I	Cl. I	Cl. I	Cl. I	Cl. I	Cl. I	Cl. I	Cl. I	Cl. I	Cl. I	Cl. I	Cl. I	-	Cl. II
IPX4	IPX4	IPX4	IPX4	IPX4	IPX4	IPX5	IPX5	IPX4	IPX4	IPX4	IPX4	IPX4	-	IP21
3.8	4.2	2.9	3.2	3.9	4.6	1.5	1.6	1.6	5.4	5.4	5.4	14.3	3	18

Cod. 5.170.084.857

09/10

Vortice Elettrosociali S.p.A
Strada Cerca, 2
Frazione di Zoate
20067 Tribiano (Milano)
Tel. (+39) 02 906991
Fax (+39) 02 90699314
Italia
www.vortice.com
export@vortice-italy.com

Vortice France
72, Rue Baratte-Cholet
94106 Saint Maur
Cedex
Tél. (+33) 1.55.12.50.00
Fax (+33) 1.55.12.50.01
France
www.vortice-france.com
contact@vortice-france.com

Vortice Limited
Beeches House-Eastern Avenue
Burton on Trent
DE13 0BB
Tel. (+44) 1283-49.29.49
Fax (+44) 1283-54.41.21
United Kingdom
www.vortice.ltd.uk
sales@vortice.ltd.uk

